

Ver. | - -

„ORIGINAL INSTRUCTIONS“

IMPORTANT NOTE:

Read this manual carefully before installing or operating your new air conditioning unit. Make sure to save this manual for future reference.

EN

For downloading manual for this product, please enter the model name at this link:

**SK**

Pre stiahnutie manuálu k tomuto produktu zadajte modelové označenie do nasledujúceho odkazu:

**HR**

Za preuzimanje priručnika za ovaj proizvod unesite naziv modela na ovu vezu:

**SL**

Za prenos navodil za uporabo tega izdelka, vnesite ime modela na tej povezavi:

**IT**

Per scaricare il manuale di questo prodotto, inserisci il nome del modello a questo link:

**CZ**

Pro stažení manuálu k tomuto produktu zadejte modelové označení do následujícího odkazu:

**DE**

Um das Handbuch für dieses Produkt herunterzuladen, geben Sie bitte den Modellnamen für diesen Link ein:

**HU**

Termék kézikönyvének letöltéséhez írja be a modell megnevezését az alábbi linkre:

**RU**

Чтобы загрузить руководство для этого продукта, введите обозначение модели по следующей ссылке:

**ES**

Para descargar el manual de este producto, ingrese la designación del modelo en el siguiente enlace:



NOTE CONCERNING PROTECTION OF ENVIRONMENT



This product must not be disposed of via normal household waste after its service life, but must be taken to a collection station for the recycling of electrical and electronic devices. The symbol on the product, the operating instructions or the packaging indicate such disposal procedures. The materials are recyclable in accordance with their respective symbols. By means of re-use, material recycling or any other form of recycling old appliances you are making an important contribution to the protection of our environment. Please ask your local council where your nearest disposal station is located.

INFORMATION CONCERNING USED REFRIGERANT MEDIUM

This unit is containing fluorinated gases included in the Kyoto protocol. The maintenance and the liquidation must be carried out by qualified personnel.

Type of refrigerant: R32

The quantity of the refrigerant: Please see the unit label.

The value GWP: 675 (1 kg R32 = 0,675 t CO₂ eq)

GWP = Global Warming Potential



Appliance filled with flammable gas R32.

In case of quality problem or other please contact your local supplier or authorized service center.

Emergency number: 112

PRODUCER

SINCLAIR CORPORATION Ltd.

16 Great Queen Street

WC2B 5AH London

United Kingdom

www.sinclair-world.com

This product was manufactured in China (Made in China).

REPRESENTATIVE

SINCLAIR Global Group s.r.o.

Purkynova 45

612 00 Brno

Czech Republic

TECHNICAL SUPPORT

SINCLAIR Global Group s.r.o.

Purkynova 45

612 00 Brno

Czech Republic

Tel.: +420 800 100 285 | Fax: +420 541 590 124

www.sinclair-solutions.com | info@sinclair-solutions.com



EN

For downloading manual for this product, please enter the model name at this link:

**SK**

Pre stiahnutie manuálu k tomuto produktu zadajte modelové označenie do nasledujúceho odkazu:

**HR**

Za preuzimanje priručnika za ovaj proizvod unesite naziv modela na ovu vezu:

**SL**

Za prenos navodil za uporabo tega izdelka, vnesite ime modela na tej povezavi:

**IT**

Per scaricare il manuale di questo prodotto, inserisci il nome del modello a questo link:

**CZ**

Pro stažení manuálu k tomuto produktu zadejte modelové označení do následujícího odkazu:

**DE**

Um das Handbuch für dieses Produkt herunterzuladen, geben Sie bitte den Modellnamen für diesen Link ein:

**HU**

Termék kézikönyvének letöltéséhez írja be a modell megnevezését az alábbi linkre:

**RU**

Чтобы загрузить руководство для этого продукта, введите обозначение модели по следующей ссылке:

**ES**

Para descargar el manual de este producto, ingrese la designación del modelo en el siguiente enlace:





sinclair

AIR CONDITIONING

INDOOR UNIT

Explanation of symbols

WARNING

This symbol indicates the possibility of death or serious injury.

CAUTION

This symbol indicates the possibility of injury or damage to property.

NOTICE

Indicates important information. Failure to observe it may result in damage to property.

Disclaimer

The manufacturer shall bear no liability for any injury and/or property loss caused by the following:

1. Damage to the product due to its misuse or mishandling.
2. Modification, alteration and/or maintenance of the product and/or its use with other equipment contrary to the manufacturer's instructions.
3. Upon verification that the product defect is directly caused by corrosive gas.
4. Upon verification that the defect is caused by improper handling during transportation of the product.
5. Operation, repair and/or maintenance of the unit without following the operating instructions and/or relevant regulations.
6. Upon verification that the problem and/or dispute is caused by the quality and/or performance of components and/or parts manufactured by other manufacturers.
7. Damage is caused by natural disasters, improper operating environment and/or force majeure.





If installation, relocation and/or repair of the air conditioner is required, please contact your dealer or local service centre first. An air conditioner must only be installed, relocated and/or repaired by an authorized company. Otherwise, serious damage, personal injury or death may occur.

If refrigerant leaks and/or needs to be extracted during installation, maintenance and/or disassembly of the equipment, contact a suitably qualified professional or take other appropriate action in accordance with local codes and regulations.

This equipment should not be operated by persons (including children) with impaired physical, sensory and/or mental abilities and/or lack of the necessary knowledge and/or experience unless they are supervised and/or instructed about the operation of the equipment by a person responsible for their safety.

Children should be supervised so that they do not play with the equipment.

Refrigerant

 <p>The appliance is filled with flammable refrigerant R32.</p>	 <p>Read the installation instructions first before installation.</p>
 <p>Read the operating instructions first before use.</p>	 <p>Read the service manual first before repairing.</p>

- To ensure the functionality of the air conditioner, a special refrigerant is circulated in the system. The refrigerant used is R32 fluoride, which is specially purified. The refrigerant is flammable and odourless. If it leaks accidentally, it can explode under certain conditions. However, the flammability of the refrigerant is very low. It can only be ignited by fire.
- Compared to conventional refrigerants, R32 is a non-polluting refrigerant and does not damage the ozone layer. It also has a low greenhouse effect. R32 has very good thermodynamic properties. As a result, really high energy efficiency can be achieved. The equipment therefore needs a smaller refrigerant charge.

WARNING

Do not use any means other than those recommended by the manufacturer to accelerate the defrosting process and/or to clean the equipment. If repair is required, contact the nearest authorized service centre. Any repairs carried out by unauthorized persons can be dangerous. The equipment should be located in a room where there is no permanent risk of ignition of flammable substances (for example, an open fire, a running gas burner and/or an electric heater with hot coils). Do not puncture the refrigerant pipe and/or throw it into a fire. The equipment is to be installed, operated or stored in a room with a floor area greater than $X \text{ m}^2$. (For area size X, see table "a" in the section "Safe handling of flammable refrigerant".) The appliance is filled with flammable refrigerant R32. Follow the manufacturer's instructions exactly when carrying out repairs. Keep in mind that the refrigerant may not give off any odour. Read the specialist instructions.



This equipment should not be operated by persons (including children) with impaired physical, sensory and/or mental abilities and/or lack of the necessary knowledge and/or experience unless they are supervised and/or instructed about the operation of the equipment by a person responsible for their safety. Children should be supervised so that they do not play with the equipment.

- 1) The WiFi module operates in the 2400-2483.5 MHz frequency band.
- 2) The maximum transmission power in this band is 20 dBm.



R32: GWP 675 This designation means that this product must not be disposed of in normal municipal waste. Please recycle it responsibly to prevent damage to the environment and human health that may occur when the product is disposed of improperly, and to contribute to the sustainable reuse of natural resources. To dispose of used equipment, use the appropriate waste collection service or contact the dealer from whom the product was purchased. They can take the product and recycle it in an environmentally friendly way. If installation, relocation and/or repair of the air conditioner is required, please contact your dealer or local service centre first. An air conditioner must only be installed, relocated and/or repaired by an authorized company. Otherwise, serious damage, personal injury or death may occur.

Safe handling of flammable refrigerant

Qualification requirements for installers and maintenance workers

- All personnel working on air conditioning systems should have a valid certificate issued by an authorised organisation and a qualification for working with refrigeration systems recognised in the industry. If other technicians are required to maintain and/or repair the equipment, they should be supervised by a person qualified in the use of flammable refrigerants.
- The equipment should only be repaired in accordance with the procedure recommended by the equipment manufacturer.

Installation notes

- The air conditioner may only be installed in a room that has more than the minimum floor area. The minimum room area is indicated on the nameplate or in the following table.
- It is forbidden to drill holes in the refrigerant pipe and/or to throw it into a fire.
- After installation, a test must be carried out to ensure that no refrigerant leaks from the equipment.

Table a: Minimum room area (m²)

Refrigerant charge (kg)	Floor installation	Window installation	Wall installation	Ceiling installation
≤1.2	/	/	/	/
1.3	14.5	5.2	1.6	1.1
1.4	16.8	6.1	1.9	1.3
1.5	19.3	7	2.1	1.4
1.6	22	7.9	2.4	1.6
1.7	24.8	8.9	2.8	1.8
1.8	27.8	10	3.1	2.1
1.9	31	11.2	3.4	2.3
2	34.3	12.4	3.8	2.6
2.1	37.8	13.6	4.2	2.8
2.2	41.5	15	4.6	3.1
2.3	45.4	16.3	5	3.4
2.4	49.4	17.8	5.5	3.7
2.5	53.6	19.3	6	4

Maintenance notes

- Check that the maintenance area and room floor area meet the requirements specified on the nameplate.
 - The equipment may only be operated in rooms that meet the requirements on the nameplate.
- Check that the maintenance area is well ventilated.
 - Constant ventilation must be ensured during work.

- Check that the maintenance area is free of open fire and/or potential sources of fire.
 - There must be no open fire in the maintenance area and a “No Smoking” warning sign must be displayed.
- Check that the labels on the equipment are in good condition.
 - Replace warning signs that are not visible or are damaged.

Soldering

- If you have to cut and/or solder the pipes of the refrigerant system during maintenance, follow the steps below:
 - a) Switch off the equipment and disconnect it from the power supply.
 - b) Extract the refrigerant.
 - c) Vacuate.
 - d) Clean the tubes with nitrogen gas (N₂).
 - e) Perform cutting and/or soldering.
 - f) Put the equipment into operation.
- Refrigerant for recycling must be stored in a special container.
- Make sure that there is no open fire near the vacuum pump exhaust and that the area is well ventilated.

Refilling the refrigerant

- When filling, use equipment that is designed exclusively for R32 refrigerant. Make sure that the different types of refrigerants do not contaminate each other. When filling the refrigerant, the refrigerant container should be in an upright position.
- When filling is complete, affix a label to the equipment with the details of the refrigerant added.
- Take care not to overfill the refrigerant.
- Check for refrigerant leaks after completion of filling and before test operation. A refrigerant leak check should also be carried out when the equipment is relocated.

Safety instructions for transport and storage

- Before unloading the equipment and opening the shipping package, check with a flammable gas detector.
- There must be no open fire in the area. Do not smoke.
- Observe local regulations and laws.

Safety precautions



WARNING

Installation

- Installation and maintenance must be carried out by suitably qualified personnel.
- The equipment must be installed in accordance with applicable state electrical standards, decrees and regulations.
- Use a separate power supply circuit and circuit breaker with the required parameters according to the relevant safety regulations.
- All wiring for indoor and outdoor units must be done by a professional.
- Disconnect the power supply before starting any work on the electrical equipment.
- Check that the power supply meets the requirements of the air conditioner.
- An unstable power supply and/or improper connection may cause electric shock, fire and/or malfunction. Install the appropriate power cords before using the air conditioner.
- Ground resistance must comply with applicable electrical safety standards.
- The air conditioner must be properly grounded. Improper grounding may cause electric shock.
- Do not connect the power supply until installation is complete.
- Install a circuit breaker. Otherwise, the equipment may be damaged.
- When permanently connected to the power supply, a switch that disconnects all poles and whose contacts are at least 3 mm apart in the off state must be used to switch off the unit.
- The circuit breaker must protect against short circuit and overload.

Safety precautions



CAUTION

Installation

- Instructions for installation and use of this product are provided by the manufacturer.
 - Select a location that is out of reach of children and away from animals and plants. If necessary for safety reasons, erect a fence around the unit.
 - The indoor unit should be installed close to the wall. Do not use an unsuitable power cord.
 - If the air conditioner is connected via a plug, the plug should be easily accessible after installation.
 - For an air conditioner without a plug, a switch (disconnecter) or circuit breaker must be connected in the circuit.
- The green+yellow wire in the air conditioner is a ground wire that must not be used for other purposes.
 - The air conditioner is a Class I electrical device. It must be properly grounded according to the applicable standards. The earthing connection must be made by a qualified professional. Make sure to check the functionality of the earthing at all times, otherwise electric shock may occur.
 - The temperature in the cooling circuit may be high. Route the connecting cable at a sufficient distance from the refrigerant tubes.

Safety precautions



WARNING

Operation and maintenance

- This equipment may also be used by children over 8 years of age and persons with reduced physical, sensory and/or mental abilities, or persons with insufficient experience and/or knowledge, provided they are supervised and/or have been instructed about the safe use of the equipment and are aware of the possible risks.
- Children must not play with the equipment. Cleaning and user maintenance of the equipment must not be carried out by unsupervised children.
- If the power cord is damaged, it must be replaced by the manufacturer, an authorised service centre or a suitably qualified person to reduce the potential risk. Do not use an extension cord with multiple outlets or a socket splitter for connection. Otherwise there is a risk of fire.
- Disconnect the air conditioner from the power supply before cleaning. Otherwise, electric shock may occur.
- Do not wash the air conditioner with water, otherwise there is a risk of electric shock.
- Do not spray water on the indoor unit. Doing so may result in electric shock and/or damage to the equipment.
- Do not repair the air conditioner yourself. Doing so may result in electric shock and/or damage to the equipment. Contact your dealer.
- After removing the filter, do not touch the fins of the heat exchanger to avoid cutting yourself on the sharp edges.
- Do not stick your fingers and/or any objects into the air inlet and/or outlet vents. Doing so may cause personal injury or damage to the equipment.

Safety precautions



CAUTION

Operation and maintenance

- Do not pour water on the remote control, otherwise the remote control may be damaged.
- Do not use fire and/or a hair dryer to dry the filter, otherwise deformation of the filter and/or fire may occur.
- Do not block the air inlet and/or outlet. A malfunction could occur.
- Do not climb on the top panel of the outdoor unit or place heavy objects on it. This could result in equipment damage and/or personal injury.
- If the following conditions occur, switch off the air conditioner immediately and disconnect the power supply. Ask your dealer or authorized service centre for repair also if the following occurs:
 - The power cord is overheating or damaged.
 - Abnormal noise during operation.
 - Circuit breaker trips frequently. The air conditioner smells like something is burning.
- Refrigerant is leaking from the indoor unit.

Part names

Indoor unit

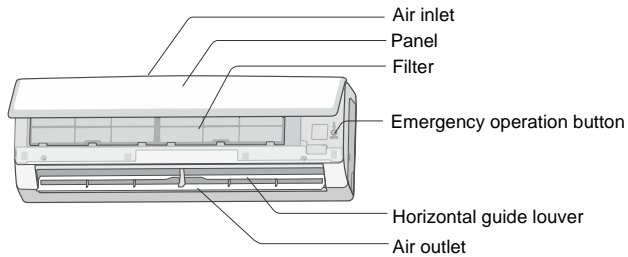

- If the remote control is lost or not working, you can switch the air conditioner on or off using the emergency button. The procedure is as follows: Open the panel, as shown in the picture, and press the emergency control button to switch the air conditioner on or off. When you switch on the air conditioner, it will operate in Auto mode.

Remote control

Buttons on the remote control





Meaning of the indicators on the display

	I FEEL function	
FAN	Set fan speed	
	Turbo mode	
	Sending signal	
Operation mode		Auto mode
		Cool mode
		Dry mode
		Fan mode
		Heat mode
	Sleep mode	
	8°C heating function	
	Health function	
	Scavenging function	
	X-FAN function	
Temperature display type		Set temperature
		Indoor ambient temperature
		Outdoor ambient temperature
	Clock	
88	Set temperature	
WiFi	WiFi function	
88:88	Set time	
ON OFF	ON/OFF timer	
	Light	
	Up & down swing	
	Child lock	

Remote control button functions

NOTICE

- This remote control is universal. It can be used for air conditioners with many functions. If a function button is pressed on the remote control that the model does not have, the unit will maintain its original operating status.
- When the air conditioner is connected to the power supply, a beep will sound. The operation indicator  lights up. You can then operate the air conditioner using the remote control.
- When the unit is switched on, after pressing the button on the remote control, the signal transmission indicator  flashes once on the remote control display and a tone sounds from the air conditioner to confirm that it is receiving the signal.

Button

Press this button to switch the unit on. Press the button again to switch the unit off.





Button

Press to lower the set temperature. If you press and hold the button for more than 2 seconds, the set temperature will start to decrease rapidly. In Auto mode, the temperature is not set.

Button

Press to increase the set temperature. If you press and hold the button for more than 2 seconds, the set temperature value will start to increase rapidly. In Auto mode, the temperature is not set.

Button

Each press of the button switches the operating mode in the following cycle: Auto , Cool , Dry , Fan  and Heat .

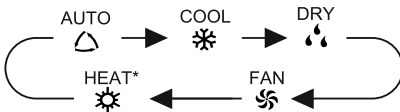



(*Note: Only on models with heating function.)

When connected to power, the default mode is set to Auto. In Auto mode, the set temperature will not appear on the display and the unit will automatically adjust the appropriate operating mode according to the room temperature to provide a comfortable environment. (If the unit is

designed for cooling only, no action will be taken when the Heat operation signal is received.)

Button

This button is used to set the fan speed in the AUTO cycle, Low , Medium , High  and then back to AUTO:

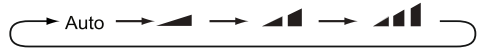



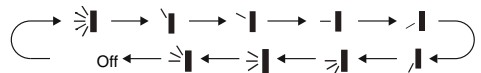

- X-FAN function: When you press the fan speed button for 2 seconds in Cool or Dry mode, the indicator  will be displayed and the fan will run for a few more minutes after the unit is switched off to dry the inside of the unit. When power is connected, the X-FAN function is switched off by default. The X-FAN function cannot be used for Auto, Fan or Heat mode. This function allows the moisture on the evaporator of the indoor unit to dry out after the unit is switched off to prevent mould growth.
 - When the X-FAN function is on: After the unit is switched off by pressing the ON/OFF button, the indoor unit fan will continue to run at a low speed for several minutes. During this time, the indoor unit fan can be stopped directly by pressing the fan speed button for 2 seconds.
 - When the X-FAN function is off: After the unit is switched off by pressing the ON/OFF button, the entire unit stops immediately.

Button

Press this button to adjust the direction of blowing air up/down in this cycle:



This remote control is universal and is used for units with different functions. If either of the commands ,  or  is sent, the unit will execute it as a command .

 indicates that the guide louver is moving as follows:

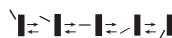





Button

Press this button to enable the I FEEL function. The unit automatically regulates the temperature according to the temperature measured by the remote control. Press this button again to switch off the I FEEL function.

- When the I FEEL function is switched on, the remote control must be positioned so that the indoor unit can receive the signals sent by the remote control.

Button

Press this button to switch Health (ion generation) or Scavenging functions on/off. The first time the button is pressed, the Scavenging function is activated. The display will show . When pressed a second time, the Scavenging and Health functions are activated simultaneously - the display shows  and . After the third press of the button, the Health and Scavenging functions are switched off. Pressing the button a fourth time switches on the Health function; the display shows . The next time the button is pressed, the cycle repeats.

NOTICE

- This function is only available on some models.

Button

Press this button to switch on the Sleep function. Press the button again to cancel this function. This function is available in Cool and Heat modes (only on models with heating). The function provides thermal comfort during sleep.

Button

Press this button to display the set temperature, room temperature or outdoor temperature on the indoor unit display. The temperature display can be cyclically switched using the remote control as follows:

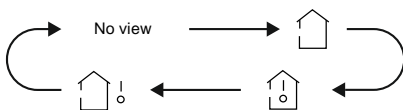

- If you select  or do not select any of the options, the display of the indoor unit will show the set temperature.

- If you select , the indoor unit display will show the temperature in the room.

If you select , the indoor unit display will show the outdoor temperature.

NOTICE



- Some models cannot display the outdoor temperature. In such a case, the indoor unit will accept a command , but display the set temperature.
- The temperature can only be displayed on indoor units that have a numeric display.

Button

Press this button to start setting the automatic switch-on time. Press this button again to cancel the auto-timer program.

When this button is pressed, indicator  disappears and the ON indicator starts flashing. 00:00 will be displayed as the ON time. Within 5 seconds, press the + or - button to set the time. Each press of these buttons will change the time by 1 minute. If you hold either of these buttons down, the time will start to increase or decrease rapidly by 1 minute and then by 10 minutes. Within 5 seconds of setting the time, confirm the setting by pressing the TIMER ON button.

Button

After pressing the CLOCK button, indicator  starts flashing. Within 5 seconds, press the + or - button to set the current time. If either of these buttons is held down for more than 2 seconds, the time will increase or decrease by 1 minute every 0.5 seconds and then by 10 minutes every 0.5 seconds. While it is flashing after setting the time, press the CLOCK button to confirm the setting. Indicator  will stop flashing.

Button



Press this button to start setting the auto-off timer. Press this button again to cancel the auto-timer program. The procedure for setting the timed power off is the same as for setting the timed power on.

Button

Press this button to activate/deactivate the Turbo function, which allows the unit to reach the set temperature in the shortest possible time. In Cool

mode, the unit will blow very cool air at maximum fan speed. In Heat mode, the unit will blow very warm air at maximum fan speed.

Button 

Press the LIGHT button to switch the display illumination on/off. Indicator  is displayed when the lighting is on. When the lighting is off, indicator  disappears.



Button 

Press the WiFi button to switch on the WiFi function. The WiFi indicator appears on the remote control. When you press and hold the WiFi button for 5 seconds, the WiFi function switches off and the WiFi indicator disappears.

When the equipment is off and the MODE and WiFi buttons are pressed simultaneously for 1 second, the WiFi module resets to factory settings. This function is only available on some models.

■ Button combination functions

Combination of + and - buttons:
Child lock

Press the + and - buttons at the same time to lock or unlock the buttons on the remote control. When the remote control is locked, indicator  is displayed. Indicator  flashes three times when any button is pressed in lock mode.

Combination of MODE and - buttons:
Switching between °F and °C

When the unit is switched off, press the MODE and - buttons at the same time to switch between the temperature display in degrees Celsius (°C) or degrees Fahrenheit (°F).

Combination of TEMP and CLOCK buttons:
Energy saving function

In Cool mode, press the TEMP and CLOCK buttons at the same time to activate the Energy saving function. "SE" will appear on the remote control display. Repeat this operation to deactivate the function.

Combination of TEMP and CLOCK buttons:
8°C heating function

In Heat mode, press the TEMP and CLOCK buttons at the same time to activate the 8°C

heating function. Indicator  will appear on the remote control display and the temperature is set to 8°C. Repeat this operation to deactivate the function.

Health function (Air Ionization)

Switch on the unit, start the fan (Scavenging and X-FAN functions cannot be used) and press the Health button on the remote control to switch on the Health function. (If there is no Health button on the remote control (Health/🌿), the Health function will be on by default.)

■ Replacing the batteries in the remote control

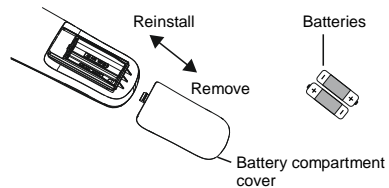

1. Press the back of the remote control at the point marked , as shown in the picture, and then slide out the battery compartment cover in the direction of the arrow.
2. Replace two 1.5V AAA batteries. Make sure that the + and - orientation of the poles of the batteries is correct.
3. Reinstall the battery cover.

NOTICE

- During operation, point the remote control signal transmitter at the receiver window on the air conditioner.
- The distance between the signal transmitter and the receiver window should be no more than 8 m and there should be no obstacles in the signal path.
- In a room with fluorescent lighting and/or a cordless telephone, interference with the signal may occur. In this case, the remote control should be brought closer to the air conditioner.
- When replacing the batteries, use the same type of batteries. Remove the batteries from the remote control if you are not going to use it for a long time.
- Replace the batteries if the indicators on the remote control display are hard to see or do not appear at all.

Control using the Ewpe Smart application

Control scheme

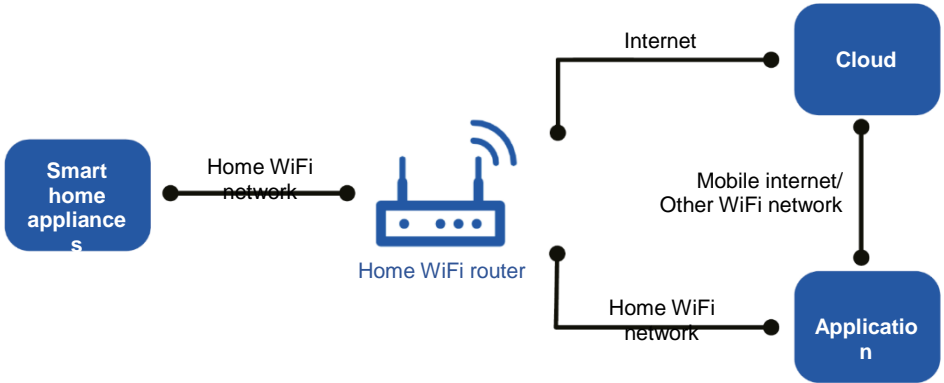

Operating systems

The required system on the user's smartphone:



iOS system
Support for iOS7.0
and higher versions



Android system
Support for Android 4.4
and higher versions

Application download and installation



Link to download the application

Use your smartphone to scan the QR code or search for the "Ewpe Smart" application in the relevant application store, download it and install. Once the "Ewpe Smart" application is installed, register an account and add your equipment to control it remotely via the application. See the "Help" section of the app for more information.

Cleaning and maintenance

! WARNING

- Before cleaning, switch off the air conditioner and disconnect it from the power supply to prevent electric shock.
- Do not wash the air conditioner with water, otherwise there is a risk of electric shock.
- Do not use volatile liquids to clean the air conditioner.
- Do not use liquid and/or aggressive cleaning agents and do not spray water or other liquids on the equipment to clean it, otherwise damage to plastic parts or even electric shock may occur.

Cleaning the surface of the indoor unit

When the surface of the indoor unit is dirty, it is recommended to use a soft dry or damp cloth to clean it.

NOTICE

- Do not remove the panel when cleaning.

Cleaning the filter

1. Open the panel.

Pull the panel up to a certain angle as shown in the picture.

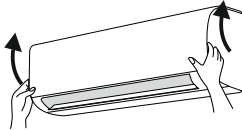

2. Remove the filter.

Remove the filter as shown.

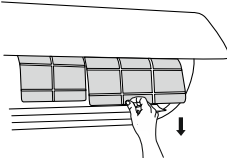

3. Clean the filter.

Clean the filter with a vacuum cleaner or water. If the filter is very dirty, use warm water to clean it (max. 45°C) and then leave the filter in a shady place to dry.

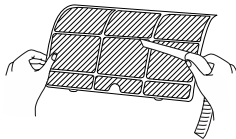

4. Install the filter.

Install the filter and then close the panel firmly.

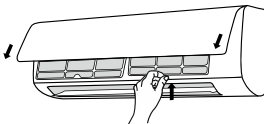

! WARNING

- The filter should be cleaned once every three months. If the equipment operates in a dusty environment, the filter can be cleaned more frequently.
- After removing the filter, do not touch the fins of the heat exchanger to avoid cutting yourself on the sharp edges.
- Do not use fire and/or a hair dryer to dry the filter, otherwise deformation of the filter and/or fire may occur.

NOTICE: Pre-season inspection

1. Check that the air inlet and/or outlet vents are not blocked.
2. Check that the circuit breaker, power plug and socket are in good condition.
3. Check that the filter is clean.
4. Check the outdoor unit mounting base for damage and/or corrosion. If it is damaged, contact your dealer.
5. Check that the drain pipe is not damaged.

NOTICE: Inspection after season

1. Disconnect the power supply.
2. Clean the filter and panel of the indoor unit.
3. Check the outdoor unit mounting base for damage and/or corrosion. If it is damaged, contact your dealer.

Recycling information

1. Many packaging materials are recyclable. Dispose of them in the appropriate containers for recyclable waste.
2. If you wish to dispose of your old air conditioner, contact your local waste collection centre or ask your dealer for advice on how to properly dispose of the equipment.

Fault code

When the air conditioner is in an abnormal condition, the temperature display on the indoor unit will flash to show the relevant fault code. Find the fault code in the table below.

Fault code	Troubleshooting
U8, H6, H3, E1, E5, E6, E8	The fault indication may be cancelled after restarting the equipment. If not, contact the service centre.
C5, F0, F1, F2	Contact the service centre.
H1	"Defrosting" status, not a fault.

NOTICE

- If other fault codes appear, contact an authorized service centre.

Checks before repair

Analysis of common phenomena

Check the following items before requesting repair of the equipment. If you are unable to solve the problem, contact your local dealer or authorized service centre.

Phenomenon	Inspected item	Solution
The indoor unit is not receiving a signal from the remote control or the remote control is not working.	Is the operation of the unit seriously disturbed (e.g. by static electricity and/or unstable voltage)?	Disconnect the power plug from the power outlet. After 3 minutes, reconnect the plug and switch on the unit.
	Is the remote control close enough to the unit?	The signal range of the remote control is 8 m.
	Are there any obstacles in the way of the signal?	Remove the obstructions.
	Is the remote control pointed at the receiver window on the unit?	Point the remote control from a suitable angle at the signal receiver window on the indoor unit.
	Do the remote control buttons not work? Is the information on the display hard to see? Or does the information not show at all?	Check the batteries. If the batteries are low, replace them.
	The remote control does not work.	Check the remote control for damage. If it is damaged, replace it.
	Is there fluorescent lighting in the room?	Bring the remote control closer to the indoor unit. Switch off the fluorescent lighting and try again.
No air is blowing from the indoor unit.	Is the air inlet/outlet of the indoor unit blocked?	Remove the obstructions.
	In Heat mode: Has the room temperature reached the set point?	When the set point is reached, air stops blowing from the indoor unit.
	Has the Heat mode just been started?	To prevent cold air from blowing out, the indoor unit fan will start after a few minutes. It is a normal phenomenon.
The air conditioner is not working.	Has there been a power failure?	Wait for the power supply to be restored.
	Is the plug loose?	Insert the plug into the socket.
	Has the circuit breaker tripped? Or is the fuse blown?	Ask a professional to check the circuit breaker and/or replace the fuse.
	Is the electrical wiring and/or power cord faulty?	Ask an electrician to repair it.
	Was the unit switched back on immediately after being switched off?	Wait 3 minutes and then switch the unit back on.
	Is the function setting using the remote control correct?	Set the function again.

Phenomenon	Inspected item	Solution
Steam is blown out of the indoor unit.	Is the room temperature and humidity high?	This is caused by the air in the room cooling down rapidly. After a while, the temperature and humidity decrease and the steam disappears.
There is an odour coming from the unit.	Is there a source of odour in the room, such as furniture, cigarettes, etc.?	Remove the source of the odour. Clean the filter.
It is not possible to set the desired temperature.	Is the unit operating in Auto mode?	The temperature cannot be set in Auto mode. To change the temperature, switch to another operating mode.
	Does your desired temperature exceed the range of settable temperatures?	Temperature setting range: 16–30°C
Insufficient cooling (heating).	Is the supply voltage too low?	Wait until the correct voltage is restored.
	Is the filter dirty?	Clean the filter.
	Is the temperature set at the correct value?	Set the temperature correctly.
	Are doors or windows open?	Close the doors and windows.
The air conditioner is not working normally.	Has the unit operation been affected by storms, electromagnetic interference, etc.?	Disconnect the unit from the power supply, reconnect it after a while and switch it back on.
The sound of running water can be heard.	Has the air conditioner just been switched on or off?	It is the sound caused by the flow of refrigerant inside the unit. It is a normal phenomenon.
A crackling sound is heard.	Has the air conditioner just been switched on or off?	It is a sound caused by friction during thermal expansion or contraction of the panel or other parts when the temperature changes.

WARNING

- If the following conditions occur, switch off the air conditioner immediately and disconnect the power supply. Then ask your dealer or authorized service for repair.
 - The power cord is overheating or damaged.
 - Abnormal noise during operation.
 - Circuit breaker trips frequently.
 - The air conditioner smells like something is burning.
 - Refrigerant is leaking from the indoor unit.
- Do not repair and/or modify the air conditioner yourself.
- If the air conditioner operates under abnormal conditions, it may cause malfunction, electric shock and/or fire.

OUTDOOR UNIT

Explanation of symbols

WARNING

This symbol indicates the possibility of death or serious injury.

CAUTION

This symbol indicates the possibility of injury or damage to property.

NOTICE

Indicates important information. Failure to observe it may result in damage to property.

Disclaimer

The manufacturer shall bear no liability for any injury and/or property loss caused by the following:

1. Damage to the product due to its misuse or mishandling.
2. Modification, alteration and/or maintenance of the product and/or its use with other equipment contrary to the manufacturer's instructions.
3. Upon verification that the product defect is directly caused by corrosive gas.
4. Upon verification that the defect is caused by improper handling during transportation of the product.
5. Operation, repair and/or maintenance of the unit without following the operating instructions and/or relevant regulations.
6. Upon verification that the problem and/or dispute is caused by the quality and/or performance of components and/or parts manufactured by other manufacturers.
7. Damage is caused by natural disasters, improper operating environment and/or force majeure.





If installation, relocation and/or repair of the air conditioner is required, please contact your dealer or local service centre first. An air conditioner must only be installed, relocated and/or repaired by an authorized company. Otherwise, serious damage, personal injury or death may occur.

If refrigerant leaks and/or needs to be extracted during installation, maintenance and/or disassembly of the equipment, contact a suitably qualified professional or take other appropriate action in accordance with local codes and regulations.

This equipment should not be operated by persons (including children) with impaired physical, sensory and/or mental abilities and/or lack of the necessary knowledge and/or experience unless they are supervised and/or instructed about the operation of the equipment by a person responsible for their safety.

Children should be supervised so that they do not play with the equipment.

Refrigerant

 <p>The appliance is filled with flammable refrigerant R32.</p>	 <p>Read the installation instructions first before installation.</p>
 <p>Read the operating instructions first before use.</p>	 <p>Read the service manual first before repairing.</p>

- To ensure the functionality of the air conditioner, a special refrigerant is circulated in the system. The refrigerant used is R32 fluoride, which is specially purified. The refrigerant is flammable and odourless. If it leaks accidentally, it can explode under certain conditions. However, the flammability of the refrigerant is very low. It can only be ignited by fire.
- Compared to conventional refrigerants, R32 is a non-polluting refrigerant and does not damage the ozone layer. It also has a low greenhouse effect. R32 has very good thermodynamic properties. As a result, really high energy efficiency can be achieved. The equipment therefore needs a smaller refrigerant charge.

WARNING

Do not use any means other than those recommended by the manufacturer to accelerate the defrosting process and/or to clean the equipment. If repair is required, contact the nearest authorized service centre. Any repairs carried out by unqualified persons can be dangerous. The equipment should be located in a room where there is no permanent risk of ignition of flammable substances (for example, an open fire, a running gas burner and/or an electric heater with hot coils). Do not puncture the refrigerant pipe and/or throw it into a fire. The equipment is to be installed, operated or stored in a room with a floor area greater than $X \text{ m}^2$. (For area size X, see table "a" in the section "Safe handling of flammable refrigerant".) The appliance is filled with flammable refrigerant R32. Follow the manufacturer's instructions exactly when carrying out repairs. Keep in mind that the refrigerant may not give off any odour. Read the specialist instructions.



This equipment should not be operated by persons (including children) with impaired physical, sensory and/or mental abilities and/or lack of the necessary knowledge and/or experience unless they are supervised and/or instructed about the operation of the equipment by a person responsible for their safety. Children should be supervised so that they do not play with the equipment.



R32: GWP 675

This designation means that this product must not be disposed of in normal municipal waste. Please recycle it responsibly to prevent damage to the environment and human health that may occur when the product is disposed of improperly, and to contribute to the sustainable reuse of natural resources.

To dispose of used equipment, use the appropriate waste collection service or contact the dealer from whom the product was purchased. They can take the product and recycle it in an environmentally friendly way.

If installation, relocation and/or repair of the air conditioner is required, please contact your dealer or local service centre first. An air conditioner must only be installed, relocated and/or repaired by an authorized company. Otherwise, serious damage, personal injury or death may occur.

Safe handling of flammable refrigerant

Qualification requirements for installers and maintenance workers

- All personnel working on air conditioning systems should have a valid certificate issued by an authorised organisation and a qualification for working with refrigeration systems recognised in the industry. If other technicians are required to maintain and/or repair the equipment, they should be supervised by a person qualified in the use of flammable refrigerants.
- The equipment should only be repaired in accordance with the procedure recommended by the equipment manufacturer.

Installation notes

- The air conditioner may only be installed in a room that has more than the minimum floor area. The minimum room area is indicated on the nameplate or in the following table.
- It is forbidden to drill holes in the refrigerant pipe and/or to throw it into a fire.
- After installation, a test must be carried out to ensure that no refrigerant leaks from the equipment.

Table a: Minimum room area (m²)

Refrigerant charge (kg)	Floor installation	Window installation	Wall installation	Ceiling installation
≤1.2	/	/	/	/
1.3	14.5	5.2	1.6	1.1
1.4	16.8	6.1	1.9	1.3
1.5	19.3	7	2.1	1.4
1.6	22	7.9	2.4	1.6
1.7	24.8	8.9	2.8	1.8
1.8	27.8	10	3.1	2.1
1.9	31	11.2	3.4	2.3
2	34.3	12.4	3.8	2.6
2.1	37.8	13.6	4.2	2.8
2.2	41.5	15	4.6	3.1
2.3	45.4	16.3	5	3.4
2.4	49.4	17.8	5.5	3.7
2.5	53.6	19.3	6	4

Maintenance notes

- Check that the maintenance area and room floor area meet the requirements specified on the nameplate.
 - The equipment may only be operated in rooms that meet the requirements on the nameplate.
- Check that the maintenance area is well ventilated.
 - Constant ventilation must be ensured during work.

- Check that the maintenance area is free of open fire and/or potential sources of fire.
 - There must be no open fire in the maintenance area and a “No Smoking” warning sign must be displayed.
- Check that the labels on the equipment are in good condition.
 - Replace warning signs that are not visible or are damaged.

Soldering

- If you have to cut and/or solder the pipes of the refrigerant system during maintenance, follow the steps below:
 - g) Switch off the equipment and disconnect it from the power supply.
 - h) Extract the refrigerant.
 - i) Vacuumate.
 - j) Clean the tubes with nitrogen gas (N₂).
 - k) Perform cutting and/or soldering.
 - l) Put the equipment into operation.
- Refrigerant for recycling must be stored in a special container.
- Make sure that there is no open fire near the vacuum pump exhaust and that the area is well ventilated.

Refilling the refrigerant

- When filling, use equipment that is designed exclusively for R32 refrigerant. Make sure that the different types of refrigerant do not contaminate each other. When filling the refrigerant, the refrigerant container should be in an upright position.
- When filling is complete, affix a label to the equipment with the details of the refrigerant added.
 - Take care not to overfill the refrigerant.
- Check for refrigerant leaks after completion of filling and before test operation. A refrigerant leak check should also be carried out when the equipment is relocated.

Safety instructions for transport and storage

- Before unloading the equipment and opening the shipping package, check with a flammable gas detector.
- There must be no open fire in the area. Do not smoke.
- Observe local regulations and laws.

Part names

Outdoor unit

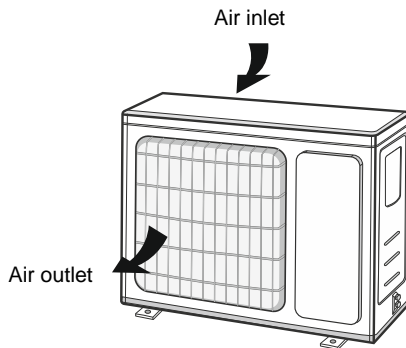

WARNING

- The actual product may look different than the picture above. Please follow the requirements for the actual product.

Installation instructions

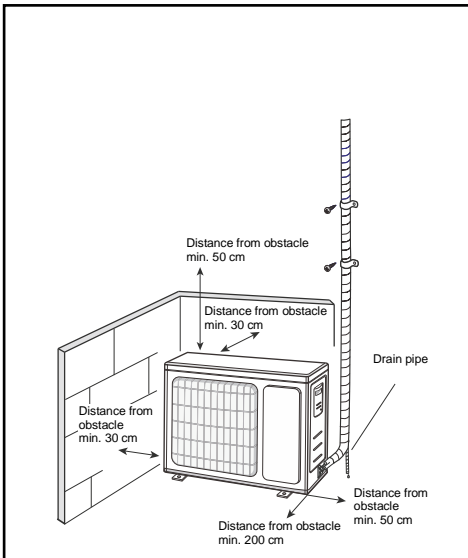

NOTICE

- Ask your local dealer for installation.
- Do not use a power cord that does not have the required specifications.

NOTE CONCERNING PROTECTION OF ENVIRONMENT



This product must not be disposed of via normal household waste after its service life, but must be taken to a collection station for the recycling of electrical and electronic devices. The symbol on the product, the operating instructions or the packaging indicate such disposal procedures. The materials are recyclable in accordance with their respective symbols. By means of re-use, material recycling or any other form of recycling old appliances you are making an important contribution to the protection of our environment. Please ask your local council where your nearest disposal station is located.

INFORMATION CONCERNING USED REFRIGERANT MEDIUM

This unit is containing fluorinated gases included in the Kyoto protocol. The maintenance and the liquidation must be carried out by qualified personnel.

Type of refrigerant: R32

The quantity of the refrigerant: Please see the unit label.

The value GWP: 675 (1 kg R32 = 0,675 t CO₂ eq)

GWP = Global Warming Potential



Appliance filled with flammable gas R32.

In case of quality problem or other please contact your local supplier or authorized service center.

Emergency number: 112

PRODUCER

SINCLAIR CORPORATION Ltd.

16 Great Queen Street

WC2B 5AH London

United Kingdom

www.sinclair-world.com

This product was manufactured in China (Made in China).

REPRESENTATIVE

SINCLAIR Global Group s.r.o.

Purkynova 45

612 00 Brno

Czech Republic

TECHNICAL SUPPORT

SINCLAIR Global Group s.r.o.

Purkynova 45

612 00 Brno

Czech Republic

Tel.: +420 800 100 285 | Fax: +420 541 590 124

www.sinclair-solutions.com | info@sinclair-solutions.com



EN

For downloading manual for this product, please enter the model name at this link:

**SK**

Pre stiahnutie manuálu k tomuto produktu zadajte modelové označenie do nasledujúceho odkazu:

**HR**

Za preuzimanje priručnika za ovaj proizvod unesite naziv modela na ovu vezu:

**SL**

Za prenos navodil za uporabo tega izdelka, vnesite ime modela na tej povezavi:

**IT**

Per scaricare il manuale di questo prodotto, inserisci il nome del modello a questo link:

**CZ**

Pro stažení manuálu k tomuto produktu zadejte modelové označení do následujícího odkazu:

**DE**

Um das Handbuch für dieses Produkt herunterzuladen, geben Sie bitte den Modellnamen für diesen Link ein:

**HU**

Termék kézikönyvének letöltéséhez írja be a modell megnevezését az alábbi linkre:

**RU**

Чтобы загрузить руководство для этого продукта, введите обозначение модели по следующей ссылке:

**ES**

Para descargar el manual de este producto, ingrese la designación del modelo en el siguiente enlace:



