

UNI SPLIT FLOOR-CEILING SERIES

ASF-xxBI
ASGE-xxBI, ASGE-xxBI-3



“Original instructions”

IMPORTANT NOTE:

Read this manual carefully before installing or operating your new air conditioning unit. Make sure to save this manual for future reference.

To Users

Thank you for selecting Sinclair's product. Please read this instruction manual carefully before installing and using the product, so as to master and correctly use the product. In order to guide you to correctly install and use our product and achieve expected operating effect, we hereby instruct as below:

- (1) This appliance can be used by children aged from 8 years and above and persons with reduced physical, sensory or mental capabilities or lack of experience and knowledge if they have been given supervision or instruction concerning use of the appliance in a safe way and understand the hazards involved. Children shall not play with the appliance. Cleaning and user maintenance shall not be made by children without supervision.
- (2) In order to ensure reliability of product, the product may consume some power under stand-by status for maintaining normal communication of system and preheating refrigerant and lubricant. If the product is not to be used for long, cut off the power supply; please energize and preheat the unit in advance before reusing it.
- (3) Please properly select the model according to actual using environment, otherwise it may impact the using convenience.
- (4) This product has gone through strict inspection and operational test before leaving the factory. In order to avoid damage due to improper disassembly and inspection, which may impact the normal operation of unit, please do not disassemble the unit by yourself. You can contact with the special maintenance center of our company if necessary.
- (5) For personal injury or property loss and damage caused by improper operation such as improper installation and debugging, unnecessary maintenance, violation of related national laws and rules and industrial standard, and violation of this instruction manual, etc., we will bear no liability.
- (6) When the product is faulted and cannot be operated, please contact with our maintenance center as soon as possible by providing the following information.
 - 1) Contents of nameplate of product (model, cooling/heating capacity, product No., ex-factory date).

- 2) Malfunction status (specify the situations before and after the error occurs).
- (7) All the illustrations and information in the instruction manual are only for reference. In order to make the product better, we will continuously conduct improvement and innovation. We have the right to make necessary revision to the product from time to time due to the reason of sales or production, and reserve the right to revise the contents without further notice.
 - (8) Indoor unit must not be installed in a laundry.
 - (9) If the supply cord is damaged, it must be replaced by the manufacturer, its service agent or similarly qualified persons in order to avoid a hazard.
 - (10) SINCLAIR CORPORATION Ltd. assumes no responsibility for personal injury, property loss or equipment damage caused by improper installation and commissioning, unnecessary maintenance, or not following relevant national rules and regulations, industrial standards and requirements in this instruction manual.
 - (11) The final right to interpret for this instruction manual belongs to SINCLAIR CORPORATION Ltd.



This marking indicates that this product should not be disposed with other household wastes throughout the EU. To prevent possible harm to the environment or human health from uncontrolled waste disposal, recycle it responsibly to promote the sustainable reuse of material resources. To return your used device, please use the return and collection systems or contact the retailer where the product was purchased. They can take this product for environmental safe recycling.

1 Safety Notices (Please be sure to abide)

SPECIAL WARNING:

- (1) Be sure to comply with national gas regulations.
- (2) Do not pierce or burn.
- (3) Do not use means to accelerate the defrosting process or to clean, other than those recommended by the manufacturer.
- (4) Be aware that refrigerants may not contain an odor.
- (5) Appliance shall be installed, operated and stored in a room with a floor area larger than "X" m² ("X" see section 3.1.1) .
- (6) The appliance shall be stored in a room without continuously operating ignition sources (for example: open flames, an operating gas appliance or an operating electric heater).



PROHIBITED: This sign indicates that the operation must be prohibited.

Improper operation may cause severe damage or death to people.



WARNING: If not abide strictly, it may cause severe damage to the unit or the people.



NOTICE: If not abide strictly, it may cause slight or medium damage to the unit or the people.



OBSERVED: This sign indicates that the items must be observed.

Improper operation may cause damage to people or property.



WARNING!

This product can't be installed at corrosive, inflammable or explosive environment or the place with special requirements, such as kitchen. Otherwise, it will affect the normal operation or shorten the service life of the unit, or even cause fire hazard or serious injury. As for above special places, please adopt special air conditioner with anti-corrosive or anti-explosion function.

Please read this operating manual carefully before operating the unit.



The air conditioner is charged with inflammable refrigerant R32 (GWP: 675).



Before using the air conditioner, please read the instruction manual.



Before installing the air conditioner, please read the instruction manual.

Before repairing the air conditioner, please read the instruction manual.



The figures in this manual may be different with the material objects, please refer to the material objects for reference.



PROHIBITED

- (1) The air conditioner should be grounded to avoid electric shock. Do not connect the ground wire to gas pipe, water pipe, lightning arrester or telephone wire.
- (2) The appliance shall be stored in a well-ventilated area where the room size corresponds to the room area as specified for operation.
- (3) The appliance shall be stored in a room without continuously operating open flames (for example an operating gas appliance) and ignition sources (for example an operating electric heater).
- (4) According to federal/state/local laws and regulations, all packages and transportation materials, including nails, metal or wooden parts, and plastic packing material, must be treated in a safe way.



WARNING

- (1) Please install according to this instruction manual. Installation must be performed in accordance with the requirement of NEC and CEC by authorized personnel only.
- (2) Any person who is involved with working on or breaking into a refrigerant circuit should hold a current valid certificate from an industry-accredited assessment authority, which authorises their competence to handle refrigerants safely in accordance with an industry recognised assessment specification.
- (3) Servicing shall only be performed as recommended by the equipment manufacturer. Maintenance and repair requiring the assistance of other skilled personnel shall be carried out under the supervision of the person competent in the use of flammable refrigerants.
- (4) The appliance shall be installed in accordance with national wiring regulations.
- (5) The fixed wires connecting to the appliance must be configured with all-pole disconnection device under voltage grade III according to wiring rules.
- (6) Air conditioner should be stored with protective measures against mechanical damage caused by accident.
- (7) If the installation space for air conditioner pipe is too small, adopt a protective measure to prevent the pipe from physical damage.

(8) During installation, use the specialized accessories and components, otherwise water leakage, electric shock or fire hazard may occur.
(9) Please install the air conditioner in a secure place that can withstand the weight of air conditioner. Insecure installation may cause the air conditioner falling down and lead to injury.
(10) Be sure to adopt independent power circuit. If the power cord is damaged, it must be repaired by the manufacturer, service agent or other professional agents.
(11) The air conditioner can be cleaned only after it is turned off and power-disconnected, otherwise electric shock may occur.
(12) The air conditioner is not intended to be cleaned or maintained by children without supervision.
(13) Do not alter the setting of pressure sensor or other protective devices. If the protective devices are short-circuited or changed against rules, fire hazard or even explosion may occur.
(14) Do not operate the air conditioner with wet hands. Do not wash or sprinkle water on the air conditioner, otherwise malfunction or electric shock will occur.
(15) Do not dry the filter with naked flame or an air blower; otherwise the filter will be out of shape.
(16) If the unit is to be installed in a small space, please adopt protective measures to prevent the concentration of refrigerant from exceeding the allowable safety limit; excessive refrigerant leakage may lead to explosion.
(17) When installing or re-installing the air conditioner, please keep the refrigerant circuit away from substances other than the specified refrigerant, such as air. Any presence of foreign substances will cause abnormal pressure change or even explosion, resulting in injury.



NOTICE

(1) Do not put a finger or other objects into the air inlet or air return grill.
(2) Please adopt safety protection measures before touching the refrigerant pipe, otherwise your hands may be hurt.
(3) Please arrange the drain pipe according to the instruction manual.
(4) Never stop the air conditioner by directly cutting off the power.
(5) Please select the proper copper pipe according to the requirement for pipe thickness.
(6) Indoor unit can only be installed indoors while outdoor unit can be installed either indoors or outdoors. Never install the air conditioner in the following places: <ul style="list-style-type: none"> a) Places with oil smoke or volatile liquid: plastic parts may deteriorate and fall off or even cause water leakage. b) Places with corrosive gas: copper pipe or the welding parts may be

corroded and cause refrigerant leakage.

- (7) Adopt proper measures to protect the outdoor unit from small animals because they may damage the electric components and cause malfunction of the air conditioner.



OBSERVED

- (1) If wired control is to be used, it should be connected first before powering up the unit, otherwise the wired control may not be able to use.
- (2) When installing the indoor unit, keep it away from television, wireless waves, and fluorescent.
- (3) Only use soft dry cloth or slightly wet cloth with neutral detergent to clean the casing of the air conditioner.
- (4) Before operating the unit under low temperature, connect it to power for 8 hours. If it is stopped for a short time, for example, one night, do not cut off the power (This is to protect the compressor).

2 Product Introduction

2.1 Overall Layout

Indoor

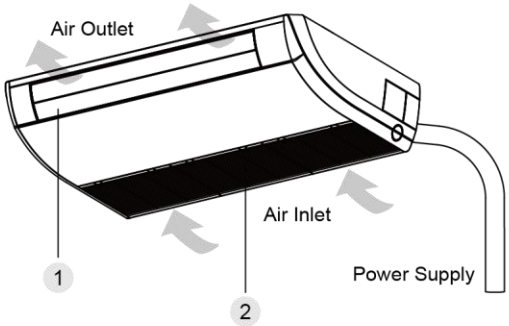

Outdoor

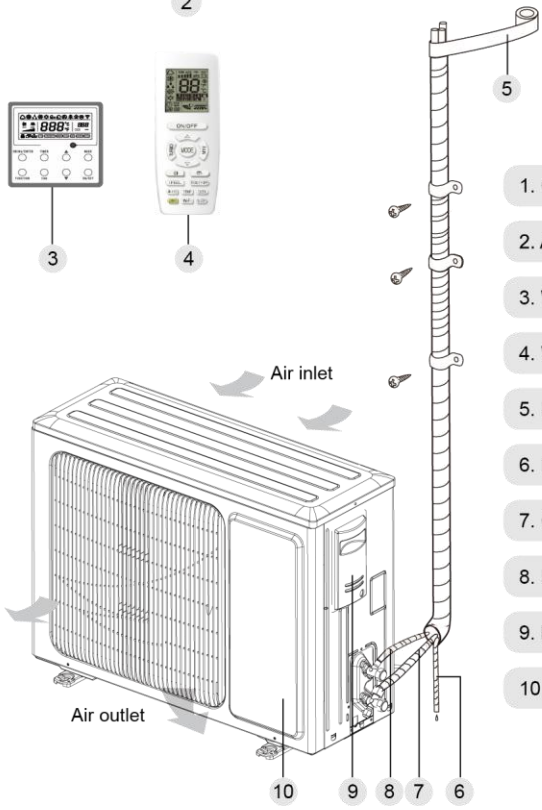









- 1. Guide louver
- 2. Air filter
- 3. Wired controller
- 4. Wireless Controller
- 5. Binding tape
- 6. Drain Pipe
- 7. Gas Pipe
- 8. Lipuid Pipe
- 9. Big Handle
- 10. Front Board

2.2 Product Operating Range

	Cooling (DB)	Heating (DB)
Outdoor temperature	-20°C~48°C	-20°C~24°C
Indoor temperature	≥16°C	≤30°C

2.3 Standard Accessories

Indoor Unit Accessories				
No.	Name	Appearance	Q'ty	Usage
1	Nut with Washer		8	To fix the hook on the cabinet of the unit.
2	Wireless Controller + Battery		1+2	To control the indoor unit
3	Insulation		1	To insulate the gas pipe
4	Insulation		1	To insulate the liquid pipe
5	Fastener		4	To fasten the sponge
6	Removal-Proof Screw Nut		1	To connect gas pipe
7	Removal-Proof Screw Nut		1	To connect liquid pipe

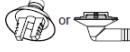
Outdoor Unit Accessories				
No	Name	Appearance	Q'ty	Usage
1	Drain Plug		1or3	To plug the unused drain hole.
2	Drainage Connector		1	To connect with the hard PVC drain pipe

Buttons on remote controller

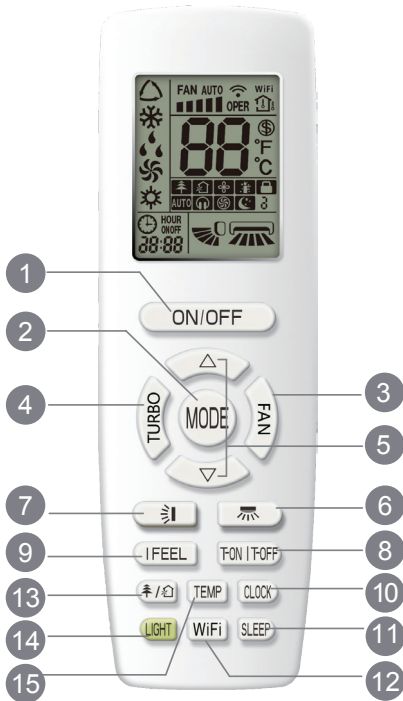

- 1 ON/OFF button
- 2 MODE button
- 3 FAN button
- 4 TURBO button
- 5 ▲ / ▼ button
- 6 button
- 7 button
- 8 T-ON / T-OFF button
- 9 I FEEL button
- 10 CLOCK button
- 11 SLEEP button
- 12 WiFi button
- 13 button
- 14 LIGHT button
- 15 TEMP button

Introduction for icons on display screen

The diagram shows the display screen of the remote controller with various icons and their corresponding functions explained. The icons are arranged as follows:

- Operation mode** (Auto mode, Cool mode, Dry mode, Fan mode, Heat mode)
- FAN AUTO** (Fan speed indicator)
- OPER** (Send signal)
- WiFi** (WiFi icon)
- 8°C** (8°C heating function)
- I feel** (I feel icon)
- Child lock** (Child lock icon)
- Sleep mode** (Sleep mode icon)
- Turbo mode** (Turbo mode icon)
- Left & right swing** (Left & right swing icon)
- Up & down swing** (Up & down swing icon)
- Quiet** (Quiet icon)
- Healthy mode** (Healthy mode icon)
- Scavenging functions** (Scavenging functions icon)
- X-FAN function** (X-FAN function icon)

Additional information:

- Set fan speed (No - fan speed. It's displayed only after turning it on.)
- This is a general remote controller. Some models have this function while some do not. Please refer to the actual models.
- Switch temperature displaying type on the unit's display

Introduction for buttons on remote controller

Note:

- This is a general use remote controller, it could be used for the air conditioners with multifunction; For some function, which the model doesn't have, if press the corresponding button on the remote controller that the unit will keep the original running status.
- After putting through the power, the air conditioner will give out a sound. Operation indicator "⏻" is ON (red indicator, the colour is different for different models). After that, you can operate the air conditioner by using remote controller.
- Under on status, pressing the button on the remote controller, the signal icon "📶" on the display of remote controller will blink once and the air conditioner will give out a "de" sound, which means the signal has been sent to the air conditioner.

1 ON/OFF button

Press this button to turn on the unit. Press this button again to turn off the unit.

2 MODE button

Press this button to select your required operation mode.



- When selecting auto mode, air conditioner will operate automatically according to ex-factory setting. Set temperature can't be adjusted and will not be displayed as well. Press "FAN" button can adjust fan speed. Press "📶" / "📶" button can adjust fan blowing angle.
- After selecting cool mode, air conditioner will operate under cool mode. Cool indicator "❄️" on indoor unit is ON. (This indicator is not available for some models.) Press "▲" or "▼" button to adjust set temperature. Press "FAN" button to adjust fan speed. Press "📶" / "📶" button to adjust fan blowing angle.
- When selecting dry mode, the air conditioner operates at low speed under dry mode. Dry indicator "💧" on indoor unit is ON. (This indicator is not available for some models.) Under dry mode, fan speed can't be adjusted. Press "📶" / "📶" button to adjust fan blowing angle.
- When selecting fan mode, the air conditioner will only blow fan, no cooling and no heating. All indicators are OFF. Press "FAN" button to adjust fan speed. Press "📶" / "📶" button to adjust fan blowing angle.
- When selecting heating mode, the air conditioner operates under heat mode. Heat indicator "☀️" on indoor unit is ON. (This indicator is not available for some models.) Press "▲" or "▼" button to adjust set temperature. Press "FAN" button to adjust fan speed. Press "📶" / "📶" button to adjust fan blowing angle. (Cooling only unit won't receive heating mode signal. If setting heat mode with remote controller, press ON/OFF button can't start up the unit).

Introduction for buttons on remote controller

Note:

- For preventing cold air, after starting up heating mode, indoor unit will delay 1~5 minutes to blow air (actual delay time is depend on indoor ambient temperature).
- Set temperature range from remote controller: 16~30°C (61-86°F);
Fan speed: auto, low speed, low-medium speed, medium speed, medium-high speed, high speed.

3 FAN button

Pressing this button can set fan speed circularly as: auto (AUTO), low (■), medium (■■), high (■■■).



Note:

- Under AUTO speed, air conditioner will select proper fan speed automatically according to ex-factory setting.
- It's Low fan speed under Dry mode.
- X-FAN function: Hold fan speed button for 2s in COOL or DRY mode, the icon "☼" is displayed and the indoor fan will continue operation for a few minutes in order to dry the indoor unit even though you have turned off the unit. After energization, X-FAN OFF is defaulted. X-FAN is not available in AUTO, FAN or HEAT mode.

This function indicates that moisture on evaporator of indoor unit will be blowed after the unit is stopped to avoid mould.

- Having set X-FAN function on: After turning off the unit by pressing ON/OFF button indoor fan will continue running for a few minutes. at low speed. In this period, Hold fan speed button for 2s to stop indoor fan directly.
- Having set X-FAN function off: After turning off the unit by pressing ON/OFF button, the complete unit will be off directly.

4 TURBO button

Under COOL or HEAT mode, press this button to turn to quick COOL or quick HEAT mode. "☼" icon is displayed on remote controller. Press this button again to exit turbo function and "☼" icon will disappear.

If start this function, the unit will run at super-high fan speed to cool or heat quickly so that the ambient temp. approaches the preset temp. as soon as possible.

5 ▲/ ▼ button

- Press "▲" or "▼" button once increase or decrease set temperature 1°C (°F). Holding "▲" or "▼" button, 2s later, set temperature on remote controller will change quickly. On releasing button after setting is finished, temperature indicator on indoor unit will change accordingly.

Introduction for buttons on remote controller



- When setting T-ON, T-OFF or CLOCK, press "▲" or "▼" button to adjust time. (Refer to CLOCK, T-ON, T-OFF buttons) When setting T-ON, T-OFF or CLOCK press "▲" or "▼" button to adjust time. (Refer to CLOCK, T-ON, T-OFF buttons)

6 button

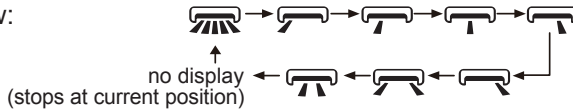
Press this button can select left & right swing angle. Fan blow angle can be selected circularly as below:











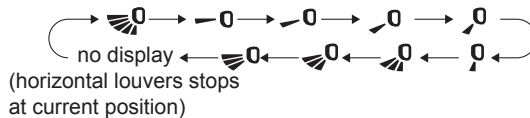

Note:

- Press this button continuously more than 2s, the main unit will swing back and forth from left to right, and then loosen the button, the unit will stop swinging and present position of guide louver will be kept immediately.
- Under swing left and right mode, when the status is switched from off to , if press this button again 2s later,  status will switch to off status directly; if press this button again within 2s, the change of swing status will also depend on the circulation sequence stated above.





7 button

Press this button can select up & down swing angle. Fan blow angle can be selected circularly as below:



- When selecting "  ", air conditioner is blowing fan automatically. Horizontal louver will automatically swing up & down at maximum angle.
- When selecting "  、  、  、  、  ", air conditioner is blowing fan at fixed position. Horizontal louver will stop at the fixed position.
- When selecting "  、  、  ", air conditioner is blowing fan at fixed angle. Horizontal louver will send air at the fixed angle.
- Hold "  " button above 2s to set your required swing angle. When reaching your required angle, release the button.

Note:

- "  、  、  " may not be available. When air conditioner receives this signal, the air conditioner will blow fan automatically.
- Press this button continuously more than 2s, the main unit will swing back and forth from up to down, and then loosen the button, the unit will stop swinging and present position of guide louver will be kept immediately.
- Under swing up and down mode, when the status is switched from off to , if press this button again 2s later,  status will switch to off status directly; if press this button again within 2s, the change of swing status will also depend on the circulation sequence stated above.

Introduction for buttons on remote controller

8 T-ON / T-OFF button

● T-ON button

"T-ON" button can set the time for timer on. After pressing this button, "🕒" icon disappears and the word "ON" on remote controller blinks. Press "▲" or "▼" button to adjust T-ON setting. After each pressing "▲" or "▼" button, T-ON setting will increase or decrease 1min. Hold "▲" or "▼" button, 2s later, the time will change quickly until reaching your required time. Press "T-ON" to confirm it. The word "ON" will stop blinking. "🕒" icon resumes displaying. Cancel T-ON: Under the condition that T-ON is started up, press "T-ON" button to cancel it.

● T-OFF button

"T-OFF" button can set the time for timer off. After pressing this button, "🕒" icon disappears and the word "OFF" on remote controller blinks. Press "▲" or "▼" button to adjust T-OFF setting. After each pressing "▲" or "▼" button, T-OFF setting will increase or decrease 1min. Hold "▲" or "▼" button, 2s later, the time will change quickly until reaching your required time. Press "T-OFF" word "OFF" will stop blinking. "🕒" icon resumes displaying. Cancel T-OFF. Under the condition that T-OFF is started up, press "T-OFF" button to cancel it.

Note:

- Under on and off status, you can set T-OFF or T-ON simultaneously.
- Before setting T-ON or T-OFF, please adjust the clock time.
- After starting up T-ON or T-OFF, set the constant circulating valid. After that, air conditioner will be turned on or turned off according to setting time. ON/OFF button has no effect on setting. If you don't need this function, please use remote controller to cancel it.

9 I FEEL button

Press this button to start I FEEL function and "🌡️" will be displayed on the remote controller. After this function is set, the remote controller will send the detected ambient temperature to the controller and the unit will automatically adjust the indoor temperature according to the detected temperature. Press this button again to close I FEEL function and "🌡️" will disappear.

- Please put the remote controller near user when this function is set. Do not put the remote controller near the object of high temperature or low temperature in order to avoid detecting inaccurate ambient temperature.

Introduction for buttons on remote controller

10 CLOCK button

Press this button to set clock time. "🕒" icon on remote controller will blink. Press "▲" or "▼" button within 5s to set clock time. Each pressing of "▲" or "▼" button, clock time will increase or decrease 1 minute. If hold "▲" or "▼" button, 2s later, time will change quickly. Release this button when reaching your required time. Press "CLOCK" button to confirm the time. "🕒" icon stops blinking.

Note:

- Clock time adopts 24-hour mode.
- The interval between two operation can't exceeds 5s. Otherwise, remote controller will quit setting status. Operation for T-ON/T-OFF is the same.

11 SLEEP button

Under COOL, or HEAT mode, press this button to start up sleep function. "🌙" icon is displayed on remote controller. Press this button again to cancel sleep function and "🌙" icon will disappear. After powered on, Sleep Off is defaulted. After the unit is turned off, the Sleep function is canceled. In this mode, the time of time can be adjusted. Under Fan、 DRY and Auto modes, this function is not available.

12 WiFi button

Press "WiFi" button to turn on or turn off WiFi function. When WiFi function is turned on, the "WiFi" icon will be displayed on remote controller; Under status of remote controller off, press "MODE" and "WiFi" buttons simultaneously for 1s, WiFi module will restore to factory default setting.

- This function is only available for some models.

13 🌳/🏠 button

Press this button to achieve the on and off of healthy and scavenging functions in operation status. Press this button for the first time to start scavenging function; LCD displays "🏠". Press the button for the second time to start healthy and scavenging functions simultaneously; LCD displays "🌳" and "🏠". Press this button for the third time to quit healthy and scavenging functions simultaneously. Press the button for the fourth time to start healthy function; LCD display "🌳". Press this button again to repeat the operation above.

- This function is applicable to partial of models.

Introduction for buttons on remote controller

14 LIGHT button

Press this button to turn off display light on indoor unit. "☹️" icon on remote controller disappears. Press this button again to turn on display light. "☹️" icon is displayed.

15 TEMP button

By pressing this button, you can see indoor set temperature, indoor ambient temperature or outdoor ambient temperature on indoor unit's display. The setting on remote controller is selected circularly as below:

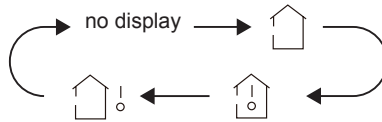

- When selecting "🏠" or no display with remote controller, temperature indicator on indoor unit displays set temperature.
- When selecting "🏠🌡️" with remote controller, temperature indicator on indoor unit displays indoor ambient temperature.
- When selecting "🏠🌡️☀️" with remote controller, temperature indicator on indoor unit displays outdoor ambient temperature.

Note:

- Outdoor temperature display is not available for some models. At that time, indoor unit receives "🏠🌡️" signal, while it displays indoor set temperature.
- It's defaulted to display set temperature when turning on the unit. There is no display in the remote controller.
- Only for the models whose indoor unit has dual-8 display.
- When selecting displaying of indoor or outdoor ambient temperature, indoor temperature indicator displays corresponding temperature and automatically turn to display set temperature after three or five seconds.

Function introduction for combination buttons

Energy-saving function

Under cooling mode, press "TEMP" and "CLOCK" buttons simultaneously to start up or turn off energy-saving function. When energy-saving function is started up, "SE" will be shown on remote controller, and air conditioner will adjust the set temperature automatically according to ex-factory setting to reach to the best energy-saving effect. Press "TEMP" and "CLOCK" buttons simultaneously again to exit energy-saving function.

Note:

- Under energy-saving function, fan speed is defaulted at auto speed and it can't be adjusted.
- Under energy-saving function, set temperature can't be adjusted. Press "TURBO" button and the remote controller won't send signal.
- Sleep function and energy-saving function can't operate at the same time. If energy-saving function has been set under cooling mode, press sleep button will cancel energy-saving function. If sleep function has been set under cooling mode, start up the energy-saving function will cancel sleep function.

8°C heating function

Under heating mode, press "TEMP" and "CLOCK" buttons simultaneously to start up or turn off 8°C heating function. When this function is started up, "Ⓢ" and "8°C" will be shown on remote controller, and the air conditioner keep the heating status at 8°C. Press "TEMP" and "CLOCK" buttons simultaneously again to exit 8°C heating function.

Note:

- Under 8°C heating function, fan speed is defaulted at auto speed and it can't be adjusted.
- Under 8°C heating function, set temperature can't be adjusted. Press "TURBO" button and the remote controller won't send signal.
- Sleep function and 8°C heating function can't operate at the same time. If 8°C heating function has been set under cooling mode, press sleep button will cancel 8°C heating function. If sleep function has been set under cooling mode, start up the 8°C heating function will cancel sleep function.
- Under °F temperature display, the remote controller will display 46 °F heating.

Child lock function

Press "▲" and "▼" simultaneously to turn on or turn off child lock function. When child lock function is on, "🔒" icon is displayed on remote controller. If you operate the remote controller, the "🔒" icon will blink three times without sending signal to the unit.

Temperature display switchover function

Under OFF status, press "▼" and "MODE" buttons simultaneously to switch temperature display between °C and °F.

Operation guide

1. After putting through the power, press "ON/OFF" button on remote controller to turn on the air conditioner.
2. Press "MODE" button to select your required mode: AUTO, COOL, DRY, FAN, HEAT.
3. Press "▲" or "▼" button to set your required temperature. (Temperature can't be adjusted under auto mode).
4. Press "FAN" button to set your required fan speed: auto, low speed, low-medium speed, medium speed, medium-high speed, high speed.
5. Press "↻" button to select fan blowing angle.

Replacement of batteries in remote controller

1. Lift the cover along the direction of arrow (as shown in Fig 1 ①).
2. Take out the original batteries (as shown in Fig 1 ②).
3. Place two 7# (AAA 1.5V) dry batteries, and make sure the position of "+" polar and "-" polar is correct (as shown in Fig 2 ③).
4. Reinstall the cover (as shown in Fig 2 ④).

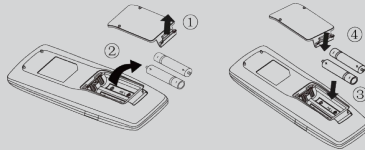

Fig.1

Fig.2

NOTICE

- During operation, point the remote control signal sender at the receiving window on indoor unit.
- The distance between signal sender and receiving window should be no more than 8m, and there should be no obstacles between them.
- Signal may be interfered easily in the room where there is fluorescent lamp or wireless telephone; remote controller should be close to indoor unit during operation.
- Replace new batteries of the same model when replacement is required.
- When you don't use remote controller for a long time, please take out the batteries.
- If the display on remote controller is fuzzy or there's no display, please replace batteries.

5 Maintenance

5.1 Failures Not Caused by Faults of the AC

(1) If your air conditioner fails to function normally, please first check the following items before maintenance:

Problem	Cause	Corrective measure
The air conditioner can't run.	If you turn off the unit and then immediately turn it on, in order to protect the compressor and avoid system overload, compressor will delay running for 3min.	Please wait for a while.
	Wire connection is wrong.	Connect wires according to the wiring diagram.
	Fuse or circuit breaker is broken.	Replace the fuse or switch on the circuit breaker.
	Power failure.	Restart after power is resumed.
	Power plug is loose.	Re-insert the power plug.
	Remote control has low battery.	Replace the batteries.
Bad cooling or heating effect.	Air inlet and outlet of indoor or outdoor units have been blocked.	Clear the obstacles and keep the room for indoor and outdoor units well ventilated.
	Improper temperature setting	Reset a proper temperature.
	Fan speed is too low.	Reset a proper fan speed.
	Air flow direction is not right.	Change the direction of air louvers.
	Doors or windows are open.	Close them.
	Exposed under direct sunshine	Put on curtains or louvers in front of the windows.
	Too many heat sources in the room.	Remove unnecessary heat sources.
	Filter is blocked or dirty.	Send for a professional to clean the filter.
	Air inlets or outlets of the units are blocked.	Clear away obstacles that are blocking the air inlets and outlets of indoor and outdoor units.

(2) The following situations are not operation failures.

Problem	Time of occurrence	Cause
Mist comes from the air conditioner.	During operation.	If the unit is running under high humidity, the wet air in the room will be quickly cooled down.
Mist comes from the air conditioner.	System switches to heating mode after defrosting.	Defrosting process will generate some water, which will turn to water vapor.
	The air conditioner is buzzing at the beginning of operation.	Temperature control will be buzzing when it starts working. The noise will become weak 1min later.
Dust comes from the air conditioner.	When the unit is turned on, it purrs.	When the system is just started, the refrigerant is not stable. About 30s later, the purr of the unit becomes low.
	About 20s after the unit first enables the heating mode or there is refrigerant brushing sound when defrosting under heating.	It's the sound of 4-way valve switching direction. The sound will disappear after the valve changes its direction.
	There is hissing sound when the unit is started or stopped and a slight hissing sound during and after operation.	It's the sound of gaseous refrigerant that stops flowing and the sound of drainage system.
	There is a sound of crunching during and after operation.	Because of temperature change, front panel and other components may be swelled up and cause abrasion sound.
	There is a hissing sound when the unit is turned on or suddenly stopped during operation or after defrosting.	Because refrigerant suddenly stops flowing or changes the flow direction.
	The unit starts operation after being unused for a long time.	Dust inside the indoor unit comes out together with the air.
The air conditioner generates some smell.	During operation.	The room smell or the smell of cigarette comes out through the indoor unit.



Notice: Check the above items and adopt the corresponding

corrective measures. If the air conditioner continues to function poorly, please stop the air conditioner immediately and contact Sinclair's authorized local service center. Ask our professional service staff to check and repair the unit.

5.2 Error Code



Warning

- ①. If abnormal things (for example, awful smell) occur, please stop the unit immediately and disconnect power. Then contact Sinclair's authorized service center. If the unit continues to run in abnormal situations, it may get damaged and cause electric shock or fire hazard.
- ②. Do not repair the air conditioner by yourself. Improper maintenance will cause electric shock or fire hazard. Please contact Sinclair's authorized service center and send for professional service staff to repair.

(1) If the display panel or wired control displays an error code, please refer to the error code meaning stated in the following table.

Number	Error code	Error
1	E1	Compressor high pressure protection
2	E2	Indoor anti-freeze protection
3	E3	Compressor low pressure protection, refrigerant lack protection and refrigerant collecting mode
4	E4	Compressor air discharge high-temperature protection
5	E6	Communication error
6	E8	Indoor fan error
7	E9	Water-full protection
8	F0	Indoor ambient temperature sensor error
9	F1	Evaporator temperature sensor error
10	F2	Condenser temperature sensor error
11	F3	Outdoor ambient temperature sensor error
12	F4	Discharge temperature sensor error
13	F5	Wired control temperature sensor error
14	C5	IDU jumper cap error
15	EE	IDU or ODU memory chip error
16	PF	Electric box sensor error
17	H3	Compressor overload protection
18	H4	Overload
19	H5	IPM protection

Number	Error code	Error
20	H6	DC fan error
21	H7	Driver out-of-step protection
22	HC	Pfc protection
23	Lc	Startup failure
24	Ld	Compressor phase-sequence protection
25	LF	Power protection
26	Lp	IDU and ODU unmatched
27	U7	4-way valve switch-over error
28	P0	Driver reset protection
29	P5	Over-current protection
30	P6	Master control and driver communication error
31	P7	Driver module sensor error
32	P8	Driver module high temperature protection
33	P9	Zero-crossing protection
34	PA	AC current protection
35	Pc	Driver current error
36	Pd	Sensor connection protection
37	PE	Temperature drift protection
38	PL	Bus low-voltage protection
39	PH	Bus high-voltage protection
40	PU	Charge loop error
41	PP	Input voltage error
42	ee	Drive memory chip error
43	C4	ODU jumper cap error
44	dJ	Phase-loss and anti-phase protection
45	oE	ODU error, for specific error please see the status of ODU indicator
46	EL	Emergency Stop(Fire alarm)



Notice: When the unit is connected with the wired controller, the error code will be simultaneously shown on it.

Instructions to the Error Indicating Lamps on the Panel of the Floor Ceiling Type Unit.

States of the Indicating Lamps:

- (1) Indicating Lamp of “POWER”: The indicating lamp will shine when power on, while it will go out when power off.
- (2) Indicating Lamp of “COOL”: The indicating lamp will shine when “COOL” is activated, while it will go out when “COOL” is deactivated.

- (3) Indicating Lamp of “HEAT”: The indicating lamp will shine when “HEAT” is activated, while it will go out when “HEAT” is deactivated.
- (4) Indicating Lamp of “TIMER”: The indicating lamp will shine when “TIMER” is activated, while it will go out when “TIMER” is deactivated or the set.

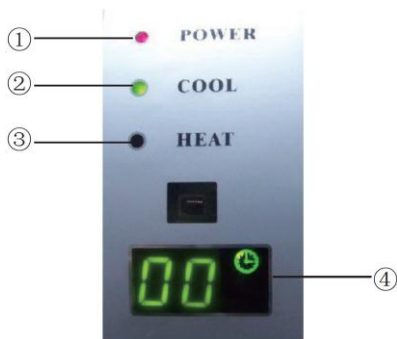

5.3 Unit Maintenance



Warning

- | |
|---|
| ①. Only professionals are allowed to carry on daily maintenance. |
| ②. Before contacting any wire, make sure power is cut off. |
| ③. Do not let any inflammable objects near the unit. |
| ④. Do not use organic solvent to clean the air conditioner. |
| ⑤. If you need to replace a component, please ask a professional to repair with a component supplied by the original manufacturer so as to ensure the unit's quality. |
| ⑥. Improper operation may get the unit broken, hit by electric shock or cause fire. |
| ⑦. Do not make the air conditioner wet or electric shock may be lead; Ensure that the air conditioner will not be cleaned by water rinsing under any circumstance. |



Notice

- | |
|---|
| ①. Before cleaning, please make sure the unit is stopped. Cut the circuit breaker and remove the power socket, otherwise, electric shock may occur. |
| ②. Do not wash the air conditioner with water, otherwise fire hazard or electric shock may occur. |
| ③. When cleaning the filter, please be careful of your steps. If you need to work high above the ground, please be extremely careful. |

5.3.1 Clean Air Filter

(1) Disassembly method of filter screen and electric box cover

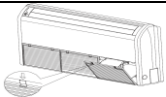
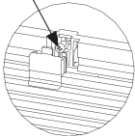
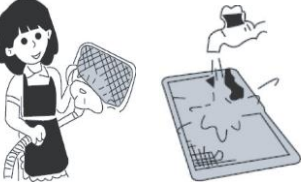
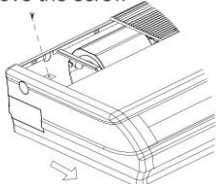
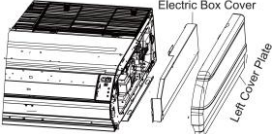
How to clean the air filter	
<p>① Open the air inlet grille.</p> <p>a) Firstly unfix two buckles on the grille as shown on the picture.</p> <p>b) Remove the screws under the buckles by a screwdriver and then open the inlet grille.</p>	 <p style="text-align: center;">Remove the screw</p> 
<p>② Clean the filter screen.</p> <p>Clean the filter screen by a vacuum cleaner or wash it by flashing water. If the oil stain on the filter can not be removed or cleaned up, wash it by warm water mixed with the detergent. Dry the filter in the shadow.</p> <p>Notice:</p> <p>a) Never use hot water over 45°C in case of color fading or turning yellow.</p> <p>b) Never dry it by fire so as to prevent the filter caught fire or deformation.</p>	
<p>③ Disassemble the left and right side board.</p> <p>a) After the grille is removed, use a screwdriver to remove the screws shown on the picture.</p> <p>b) Push the side plate as per the arrowed direction and take it down.</p>	<p style="text-align: center;">Remove the screw</p> 
<p>④ Disassemble the right side board.</p>	<p style="text-align: center;">Disassembly method of right side board Step 3.</p>
<p>⑤ Disassemble the electric box cover</p> <p>After the right side board is removed, the electric box cover will be shown up and disassemble the fixed screws on it.</p>	 <p style="text-align: right;">Electric Box Cover Left Cover Plate</p>

(2) At the Start of the Seasonal Use.

- 1) Check if there is blockage at the inlet or outlet vent of air conditioner.
- 2) Check if the earth wire has been attached reliably by the skilled serviceman.

3) Check if the exhausted batteries of the wireless controller have been replaced.

4) Check if the air filter had been installed well by professional.

Keep the power switch “On” 8 hours before the startup of the unit which has not been used for a long period.



Notice: all above should be operated by the skilled serviceman.

(3) At the End of the Seasonal Use.

1) Cut off the power supply main switch

2) Clean the air filters and other parts by the skilled serviceman.

3) Leave the fan running for 2-3 hours to dry the inside of the unit.



Notice: all above should be operated by the skilled serviceman.

5.3.2 Heat Exchanger of Outdoor Unit

Conduct cleaning for the heat exchanger of outdoor unit periodically, clean it once at least in every two months. Clean the dust and sundries on the surface of the heat exchanger with dust collector and nylon brush, if there's compressed air source; use the compressed air to blow the dust on the surface of the heat exchanger. Don't use tap water for cleaning.

5.3.3 Drainage Pipe

Periodically check if the drainage pipe is blocked to smooth the condensate water.

5.3.4 Notices at the Beginning of the Using Season

(1) Check if the air inlet/outlet of indoor/outdoor unit is blocked;

(2) Check if the ground connection is reliable;

(3) Check if the battery of remote controller is replaced;

(4) Check if the air filter screen is properly installed;

(5) If starting up again after long-term shut down, preset the power switch of air conditioner to “ON” status before 8h of operation, to preheat the crankcase of outdoor compressor;

(6) Check if the installation of outdoor unit is firm, if not, please contact with Sinclair

appointed maintenance center.

5.3.5 Maintenance at the end of the Using Season

- (1) Cut off the main power of air conditioner;
- (2) Clean the filter screen, indoor and outdoor unit;
- (3) Clean the dust and sundries in indoor and outdoor unit;
- (4) If the outdoor unit is rusty, coat the rusty location with paint to prevent it from expanding.

5.3.6 Components Replacement

Components are available in Sinclair agency or Sinclair distributors nearby.

5.4 After-Sales Services

Any quality or other issues encountered in the purchased air conditioner, please contact the local Sinclair after-sales service department.

NOTE CONCERNING PROTECTION OF ENVIRONMENT



This product must not be disposed of via normal household waste after its service life, but must be taken to a collection station for the recycling of electrical and electronic devices. The symbol on the product, the operating instructions or the packaging indicate such disposal procedures. The materials are recyclable in accordance with their respective symbols. By means of re-use, material recycling or any other form of recycling old appliances you are making an important contribution to the protection of our environment. Please ask your local council where your nearest disposal station is located.

INFORMATION CONCERNING USED REFRIGERANT MEDIUM

This unit is containing fluorinated gases included in the Kyoto protocol. The maintenance and the liquidation must be carried out by qualified personnel.

Type of refrigerant: R32

The quantity of the refrigerant: please see the unit label.

The value GWP: 675 (1 kg R32 = 0,675 t CO2 eq)

GWP = Global Warming Potential



Appliance filled with flammable gas R32.

In case of quality problem or other please contact your local supplier or authorized service center.

Emergency number: 112

PRODUCER

SINCLAIR CORPORATION Ltd.

1-4 Argyll St.

London W1F 7LD

Great Britain

www.sinclair-world.com

This product was manufactured in China (Made in China).

REPRESENTATIVE

SINCLAIR Global Group s.r.o.

Purkynova 45

612 00 Brno

Czech Republic

TECHNICAL SUPPORT

SINCLAIR Global Group s.r.o.

Purkynova 45

612 00 Brno

Czech Republic

Tel.: +420 800 100 285

Fax: +420 541 590 124

www.sinclair-solutions.com

info@sinclair-solutions.com

